

CCNA_200-125_171q_by_PenPineappleApplePen

Number: 200-125
Passing Score: 810
Time Limit: 140 min
File Version: 1.1

Brought to you by:

PenPineappleApplePen-

The **NEW** exam has **58 Questions** and **this is not complete** but may will help.

Extracted from **TEST TAKERS OF 9TUT include me**

Study also the **4 sims** (**DHCP,RIPv2,OSPF,ACL**) which can be found in the 9tut site.

NO NEED TO STUDY 545q and 62q

After your exam please try to share your experience and questions to : <http://www.9tut.com/share-your-ccna-v3-0-experience/>

AND PLEASE IF YOU KNOW MORE PLEASE SHARE!

TO WHOEVER USE THIS, GOODLUCK!



PPAP

QUESTION 1

Which technology supports the stateless assignment of IPv6 addresses?

- A. DNS
- B. DHCPv6
- C. DHCP
- D. autoconfiguration

Correct Answer: BD

Section: (none)

Explanation

Explanation/Reference:

QUESTION 2

What are two requirements for an HSRP group? (Choose two.)

- A. exactly one active router
- B. one or more standby routers
- C. one or more backup virtual routers
- D. exactly one standby active router
- E. exactly one backup virtual router

Correct Answer: AB

Section: (none)

Explanation

Explanation/Reference:

QUESTION 3

After you configure the Loopback0 interface, which command can you enter to verify the status of the interface and determine whether fast switching is enabled?

- A. Router#show ip interface loopback 0
- B. Router#show run
- C. Router#show interface loopback 0
- D. Router#show ip interface brief

Correct Answer: A

Section: (none)

Explanation

Explanation/Reference:

QUESTION 4

Which command sequence can you enter to create VLAN 20 and assign it to an interface on a switch?

- A. Switch(config)#vlan 20
Switch(config)#Interface gig x/y

- Switch(config-if)#switchport access vlan 20
- B. Switch(config)#Interface gig x/y
Switch(config-if)#vlan 20
Switch(config-vlan)#switchport access vlan 20
 - C. Switch(config)#vlan 20
Switch(config)#Interface vlan 20
Switch(config-if)#switchport trunk native vlan 20
 - D. Switch(config)#vlan 20
Switch(config)#Interface vlan 20
Switch(config-if)#switchport access vlan 20
 - E. Switch(config)#vlan 20
Switch(config)#Interface vlan 20
Switch(config-if)#switchport trunk allowed vlan 20

Correct Answer: A

Section: (none)

Explanation

Explanation/Reference:

QUESTION 5

Which three commands can you use to set a router boot image? (Choose three.)

- A. Router(config)# boot system flash c4500-p-mz.121-20.bin
- B. Router(config)# boot system tftp c7300-js-mz.122-33.SB8a.bin
- C. Router(config)#boot system rom c7301-advipservicesk9-mz.124-24.T4.bin
- D. Router> boot flash:c180x-adventerprisek9-mz-124-6T.bin
- E. Router(config)#boot flash:c180x-adventerprisek9-mz-124-6T.bin
- F. Router(config)#boot bootldr bootflash:c4500-jk9s-mz.122-23f.bin

Correct Answer: ABC

Section: (none)

Explanation

Explanation/Reference:

QUESTION 6

Which two statements about IPv6 and routing protocols are true? (Choose two.)

- A. Link-local addresses are used to form routing adjacencies.
- B. OSPFv3 was developed to support IPv6 routing.
- C. EIGRP, OSPF, and BGP are the only routing protocols that support IPv6.
- D. Loopback addresses are used to form routing adjacencies.
- E. EIGRPv3 was developed to support IPv6 routing.

Correct Answer: AB

Section: (none)

Explanation

Explanation/Reference:

QUESTION 7

If primary and secondary root switches with priority 16384 both experience catastrophic losses, which tertiary switch can take over?

- A. a switch with priority 20480
- B. a switch with priority 8192
- C. a switch with priority 4096
- D. a switch with priority 12288

Correct Answer: A

Section: (none)

Explanation

Explanation/Reference:

QUESTION 8

Which two statements about late collisions are true? (Choose two.)

- A. They may indicate a duplex mismatch.
- B. By definition, they occur after the 512th bit of the frame has been transmitted.
- C. They indicate received frames that did not pass the FCS match.
- D. They are frames that exceed 1518 bytes.
- E. They occur when CRC errors and interference occur on the cable.

Correct Answer: AB

Section: (none)

Explanation

Explanation/Reference:

QUESTION 9

Which command can you enter to set the default route for all traffic to an interface?

- A. `router(config)#ip route 0.0.0.0 0.0.0.0 GigabitEthernet0/1`
- B. `router(config)#ip route 0.0.0.0 255.255.255.255 GigabitEthernet0/1`
- C. `router(config-router)#default-information originate`
- D. `router(config-router)#default-information originate always`

Correct Answer: A

Section: (none)

Explanation

Explanation/Reference:

QUESTION 10

Which two spanning-tree port states does RSTP combine to allow faster convergence? (Choose two.)

- A. blocking
- B. listening
- C. learning
- D. forwarding
- E. discarding

Correct Answer: AB
Section: (none)
Explanation

Explanation/Reference:

QUESTION 11

If a router has four interfaces and each interface is connected to four switches, how many broadcast domains are present on the router?

- A. 1
- B. 2
- C. 4
- D. 8

Correct Answer: C
Section: (none)
Explanation

Explanation/Reference:

QUESTION 12

The left describes the types of cables, while the right describes the purposes of the cables. Drag the items on the left to the proper locations. (Not all items can be used.)

(THE COMMUNITY SHARED THAT THERE IS ANOTHER OPTION SO STUDY ALL OF WHAT THIS CABLES ARE FOR)

- crossover
- null modem
- straight-through
- rollover
- 9-25 pin serial

- switch access port to router
- switch to switch
- PC COM to Switch Console Port

Select and Place:

- crossover
- null modem
- straight-through
- rollover
- 9-25 pin serial

- switch access port to router
- switch to switch
- PC COM to Switch Console Port

Correct Answer:

-
- null modem
-
-
- 9-25 pin serial

- straight-through
- crossover
- rollover

Section: (none)
Explanation

Explanation/Reference:

QUESTION 13

Match the items on the left with appropriate OSI layer on the right. (Not all options are used.)

- bits
- packets
- udp
- IP address
- segments
- MAC address
- windowing
- routing
- switching

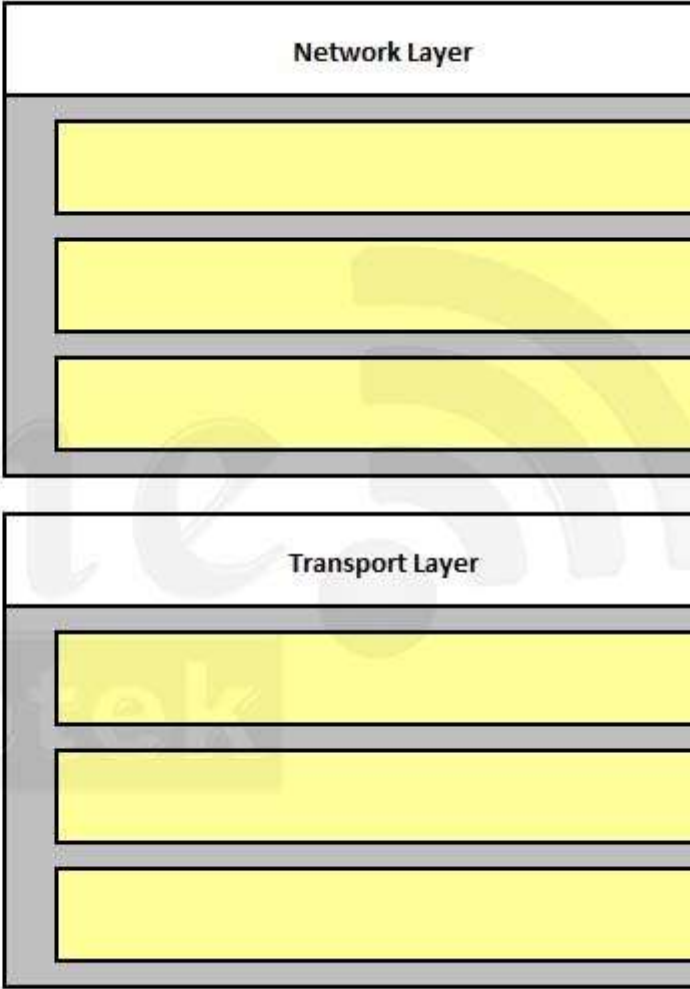

Select and Place:

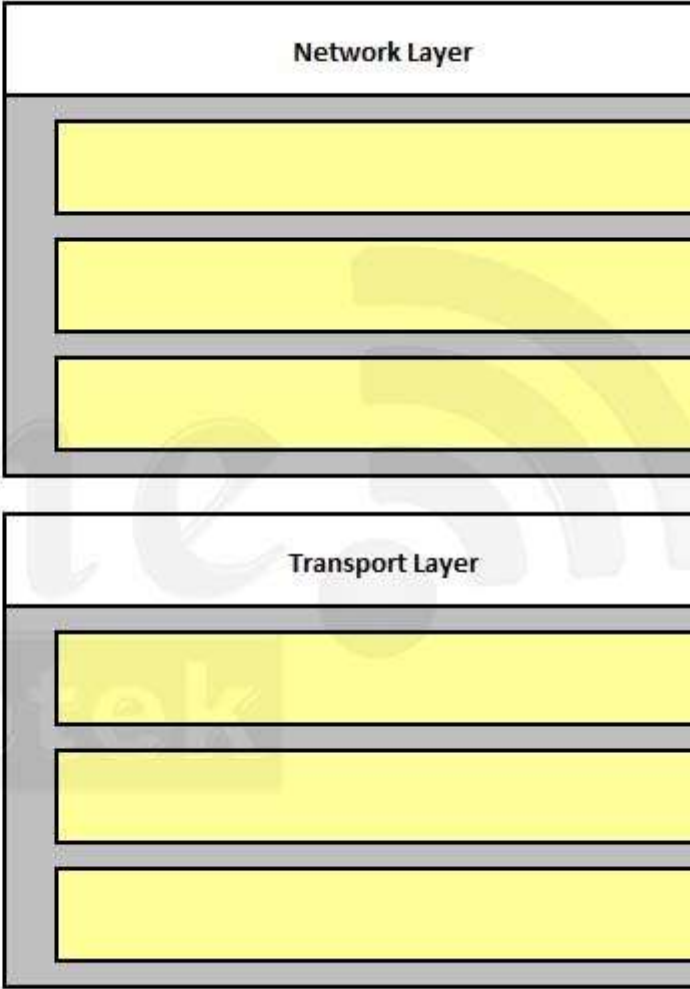

Correct Answer:

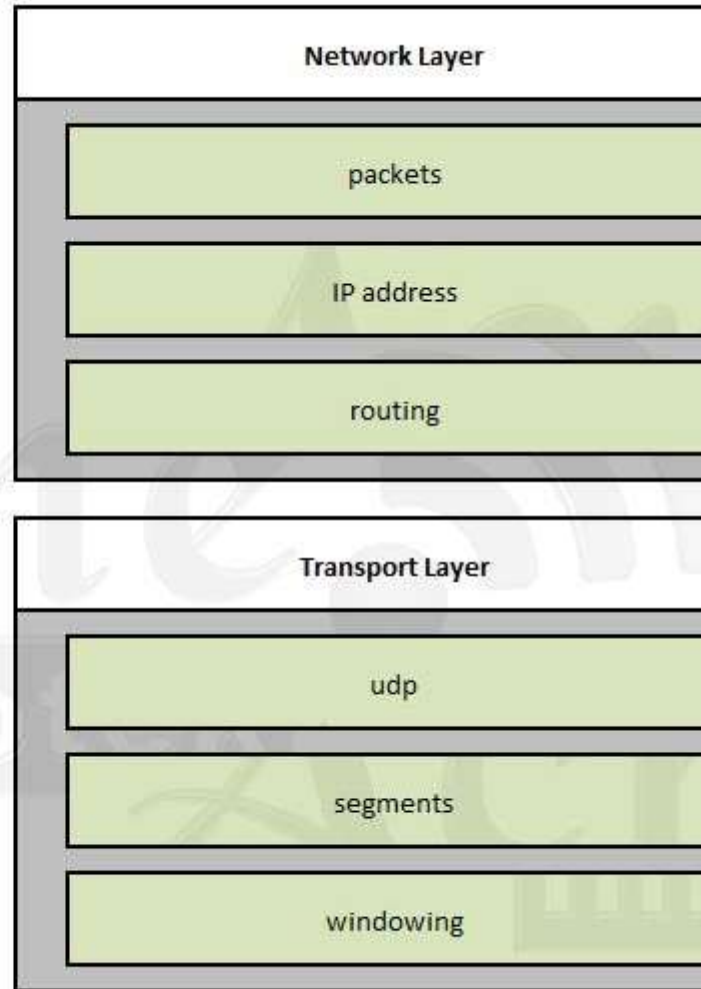

Section: (none)
Explanation

Explanation/Reference:

QUESTION 14

Which command enables IPv6 forwarding on a Cisco router?

- A. ipv6 local
- B. ipv6 host
- C. ipv6 unicast-routing
- D. ipv6 neighbor

Correct Answer: C
Section: (none)
Explanation

Explanation/Reference:

QUESTION 15

Refer to the exhibit. What is the most appropriate summarization for these routes?

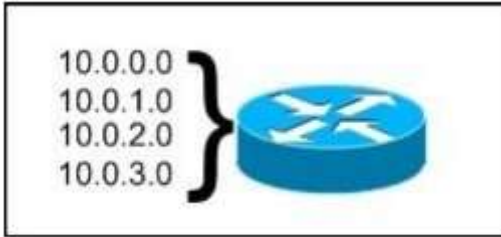

- A. 10.0.0.0 /21
- B. 10.0.0.0 /22
- C. 10.0.0.0 /23
- D. 10.0.0.0 /24

Correct Answer: B

Section: (none)

Explanation

Explanation/Reference:

The 10.0.0.0/22 subnet mask will include the 10.0.0.0, 10.0.1.0, 10.0.2.0, and 10.0.3.0 networks, and only those four networks.

QUESTION 16

Which set of commands is recommended to prevent the use of a hub in the access layer?

- A. switch(config-if)#switchport mode trunk
switch(config-if)#switchport port-security maximum 1
- B. switch(config-if)#switchport mode trunk
switch(config-if)#switchport port-security mac-address 1
- C. switch(config-if)#switchport mode access
switch(config-if)#switchport port-security maximum 1
- D. switch(config-if)#switchport mode access
switch(config-if)#switchport port-security mac-address 1

Correct Answer: C

Section: (none)

Explanation

Explanation/Reference:**QUESTION 17**

A router has learned three possible routes that could be used to reach a destination network. One route is from EIGRP and has a composite metric of 20514560. Another route is from OSPF with a metric of 782. The last is from RIPv2 and has a metric of 4. Which route or routes will the router install in the routing table?

- A. the OSPF route
- B. the EIGRP route
- C. the RIPv2 route
- D. all three routes
- E. the OSPF and RIPv2 routes

Correct Answer: B

Section: (none)

Explanation

Explanation/Reference:

QUESTION 18

Two routers named Atlanta and Brevard are connected via their serial interfaces as illustrated, but they are unable to communicate. The Atlanta router is known to have the correct configuration.



Given the partial configurations, identify the fault on the Brevard router that is causing the lack of connectivity

- A. incompatible IP address
- B. insufficient bandwidth
- C. incorrect subnet mask
- D. incompatible encapsulation
- E. link reliability too low
- F. IPCP closed

Correct Answer: D

Section: (none)

Explanation

Explanation/Reference:

QUESTION 19

A network administrator needs to configure a serial link between the main office and a remote location. The router at the remote office is a non-Cisco router. How should the network administrator configure the serial interface of the main office router to make the connection?

- A. Main(config)# interface serial 0/0
Main(config-if)# ip address 172.16.1.1 255.255.255.252
Main(config-if)# no shut
- B. Main(config)# interface serial 0/0
Main(config-if)# ip address 172.16.1.1 255.255.255.252
Main(config-if)# encapsulation ppp
Main(config-if)# no shut
- C. Main(config)# interface serial 0/0
Main(config-if)# ip address 172.16.1.1 255.255.255.252
Main(config-if)# encapsulation frame-relay

```
Main(config-if)# authentication chap
Main(config-if)# no shut
```

- D. Main(config)# interface serial 0/0
Main(config-if)#ip address 172.16.1.1 255.255.255.252
Main(config-if)#encapsulation ietf
Main(config-if)# no shut

Correct Answer: B

Section: (none)

Explanation

Explanation/Reference:

QUESTION 20

Which Layer 2 protocol encapsulation type supports synchronous and asynchronous circuits and has built-in security mechanisms?

- A. HDLC
- B. PPP
- C. X.25
- D. Frame Relay

Correct Answer: B

Section: (none)

Explanation

Explanation/Reference:

QUESTION 21

Refer to the exhibit. The two connected ports on the switch are not turning orange or green. What would be the most effective steps to troubleshoot this physical layer problem? (Choose three.)

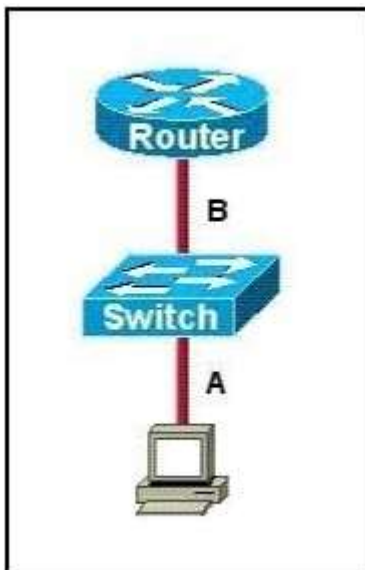

- A. Ensure that the Ethernet encapsulations match on the interconnected router and switch ports.
- B. Ensure that cables A and B are straight-through cables.
- C. Ensure cable A is plugged into a trunk port.

- D. Ensure the switch has power.
- E. Reboot all of the devices.
- F. Reseat all cables.

Correct Answer: BDF

Section: (none)

Explanation

Explanation/Reference:

QUESTION 22

A network administrator is troubleshooting the OSPF configuration of routers R1 and R2. The routers cannot establish an adjacency relationship on their common Ethernet link.

```

R1: Ethernet0 is up, line protocol is up
     Internet address 192.168.1.2/24, Area 0
     Process ID 1, Router ID 192.168.31.33, Network Type BROADCAST, Cost: 10
     Transmit Delay is 1 sec, State DR, Priority 1
     Designated Router (ID) 192.168.31.33, Interface address 192.168.1.2
     No backup designated router on this network
     Timer intervals configured, Hello 5, Dead 20, Wait 20, Retransmit 5

R2: Ethernet0 is up, line protocol is up
     Internet address 192.168.1.1/24, Area 0
     Process ID 2, Router ID 192.168.31.11, Network Type BROADCAST, Cost: 10
     Transmit Delay is 1 sec, State DR, Priority 1
     Designated Router (ID) 192.168.31.11, Interface address 192.168.1.1
     No backup designated router on this network
     Timer intervals configured, Hello 10, Dead 40, Wait 40, Retransmit 5
  
```

The graphic shows the output of the show ip ospf interface e0 command for routers R1 and R2. Based on the information in the graphic, what is the cause of this problem?

- A. The OSPF area is not configured properly.
- B. The priority on R1 should be set higher.
- C. The cost on R1 should be set higher.
- D. The hello and dead timers are not configured properly.
- E. A backup designated router needs to be added to the network.
- F. The OSPF process ID numbers must match.

Correct Answer: D

Section: (none)

Explanation

Explanation/Reference:

QUESTION 23

What will happen if a private IP address is assigned to a public interface connected to an ISP?

- A. Addresses in a private range will be not be routed on the Internet backbone.
- B. Only the ISP router will have the capability to access the public network.
- C. The NAT process will be used to translate this address to a valid IP address.
- D. A conflict of IP addresses happens, because other public routers can use the same range.

Correct Answer: A

Section: (none)

Explanation

Explanation/Reference:

QUESTION 24

Refer to the exhibit. The Bigtime router is unable to authenticate to the Littletime router. What is the cause of the problem?

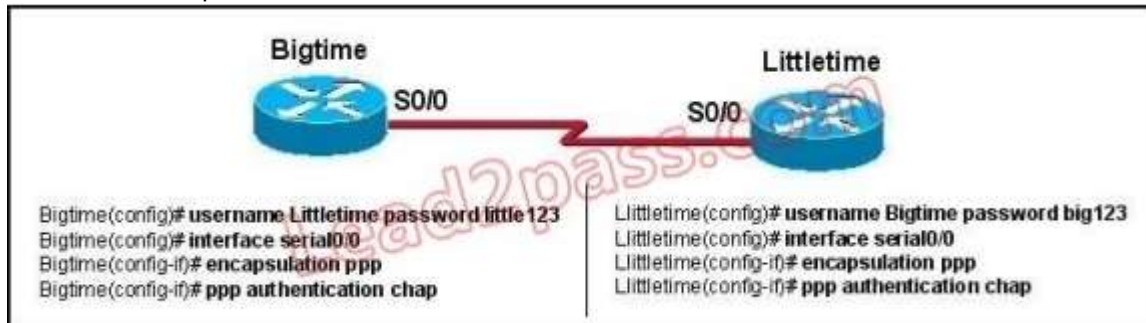

- A. The usernames are incorrectly configured on the two routers.
- B. The passwords do not match on the two routers.
- C. CHAP authentication cannot be used on a serial interface.
- D. The routers cannot be connected from interface S0/0 to interface S0/0.
- E. With CHAP authentication, one router must authenticate to another router. The routers cannot be configured to authenticate to each other.

Correct Answer: B

Section: (none)

Explanation

Explanation/Reference:

QUESTION 25

What will be the result if the following configuration commands are implemented on a Cisco switch?

```
Switch(config-if)# switchport port-security
Switch(config-if)# switchport port-security mac-address sticky
```

- A. A dynamically learned MAC address is saved in the startup-configuration file.
- B. A dynamically learned MAC address is saved in the running-configuration file.
- C. A dynamically learned MAC address is saved in the VLAN database.
- D. Statically configured MAC addresses are saved in the startup-configuration file if frames from that address are received.
- E. Statically configured MAC addresses are saved in the running-configuration file if frames from that address are received.

Correct Answer: B

Section: (none)

Explanation

Explanation/Reference:

QUESTION 26

Refer to the exhibit. The following commands are executed on interface fa0/1 of 2950Switch.

```
2950Switch(config-if)# switchport port-security
2950Switch(config-if)# switchport port-security mac-address sticky
2950Switch(config-if)# switchport port-security maximum 1
```

The Ethernet frame that is shown arrives on interface fa0/1.

What two functions will occur when this frame is received by 2950Switch? (Choose two.)

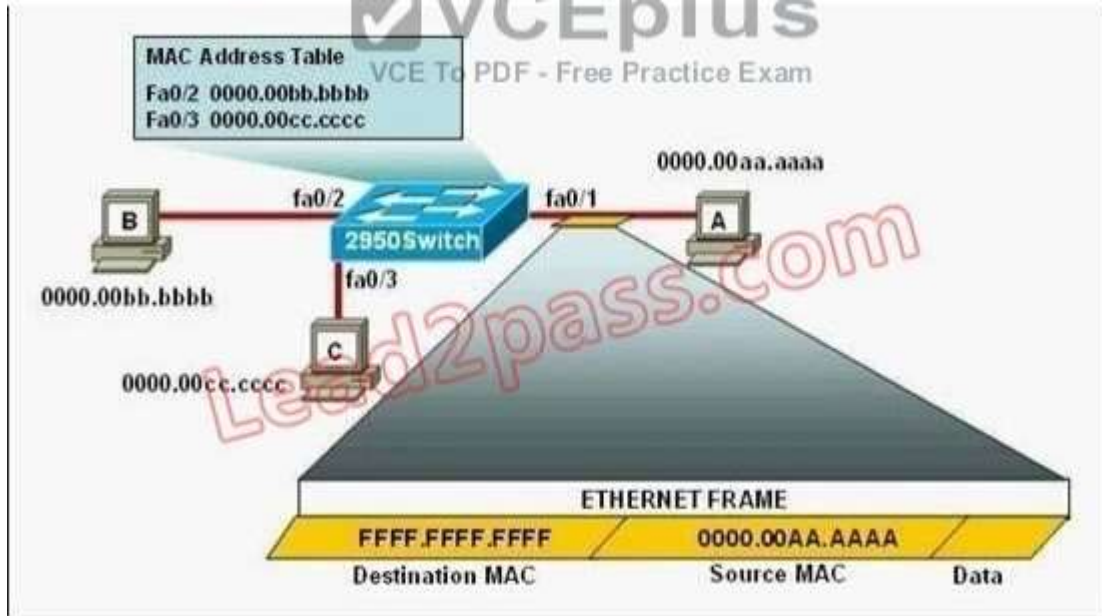

- A. The MAC address table will now have an additional entry of fa0/1 FFFF.FFFF.FFFF.
- B. Only host A will be allowed to transmit frames on fa0/1.
- C. This frame will be discarded when it is received by 2950Switch.
- D. All frames arriving on 2950Switch with a destination of 0000.00aa.aaaa will be forwarded out fa0/1.
- E. Hosts B and C may forward frames out fa0/1 but frames arriving from other switches will not be forwarded out fa0/1.
- F. Only frames from source 0000.00bb.bbbb, the first learned MAC address of 2950Switch, will be forwarded out fa0/1.

Correct Answer: BD

Section: (none)

Explanation

Explanation/Reference:

QUESTION 27

Which command would you configure globally on a Cisco router that would allow you to view directly connected Cisco devices?

- A. enable cdp
- B. cdp enable
- C. cdp run
- D. run cdp

Correct Answer: C

Section: (none)

Explanation

Explanation/Reference:

QUESTION 28

A Cisco router is booting and has just completed the POST process. It is now ready to find and load an IOS image. What function does the router perform next?

- A. It checks the configuration register.
- B. It attempts to boot from a TFTP server.
- C. It loads the first image file in flash memory.
- D. It inspects the configuration file in NVRAM for boot instructions.

Correct Answer: A

Section: (none)

Explanation

Explanation/Reference:

QUESTION 29

What are three advantages of VLANs? (Choose three.)

- A. VLANs establish broadcast domains in switched networks.
- B. VLANs utilize packet filtering to enhance network security.
- C. VLANs provide a method of conserving IP addresses in large networks.
- D. VLANs provide a low-latency internetworking alternative to routed networks.
- E. VLANs allow access to network services based on department, not physical location.
- F. VLANs can greatly simplify adding, moving, or changing hosts on the network.

Correct Answer: AEF

Section: (none)

Explanation

Explanation/Reference:

QUESTION 30

Refer to the exhibit. The output that is shown is generated at a switch. Which three statements are true? (Choose three.)

```

Switch# show spanning-tree vlan 30
VLAN0030
Spanning tree enabled protocol rstp
Root ID Priority 24606
Address 00d0.047b.2800
This bridge is the root
Hello Time 2 sec Max Age 20 sec Forward Delay 15 sec
Bridge ID Priority 24606 (priority 24576 sys-id-ext 30)
Address 00d0.047b.2800
Hello Time 2 sec Max Age 20 sec Forward Delay 15 sec
Aging Time 300
Interface Role Sts Cost Prio.Nbr Type
-----
Fa1/1 Desg FWD 4 128.1 p2p
Fa1/2 Desg FWD 4 128.2 p2p
Fa5/1 Desg FWD 4 128.257 p2p

```

- A. All ports will be in a state of discarding, learning, or forwarding.
- B. Thirty VLANs have been configured on this switch.
- C. The bridge priority is lower than the default value for spanning tree.
- D. All interfaces that are shown are on shared media.
- E. All designated ports are in a forwarding state.
- F. This switch must be the root bridge for all VLANs on this switch.

Correct Answer: ACE

Section: (none)

Explanation

Explanation/Reference:

QUESTION 31

Which two commands can be used to verify a trunk link configuration status on a given Cisco switch interface? (Choose two.)

- A. show interface trunk
- B. show interface interface
- C. show ip interface brief
- D. show interface vlan
- E. show interface switchport

Correct Answer: AE

Section: (none)

Explanation

Explanation/Reference:

QUESTION 32

Which two states are the port states when RSTP has converged? (Choose two.)

- A. discarding

- B. listening
- C. learning
- D. forwarding
- E. disabled

Correct Answer: AD

Section: (none)

Explanation

Explanation/Reference:

QUESTION 33

Refer to the exhibit. A technician has installed SwitchB and needs to configure it for remote access from the management workstation connected to SwitchA . Which set of commands is required to accomplish this task?

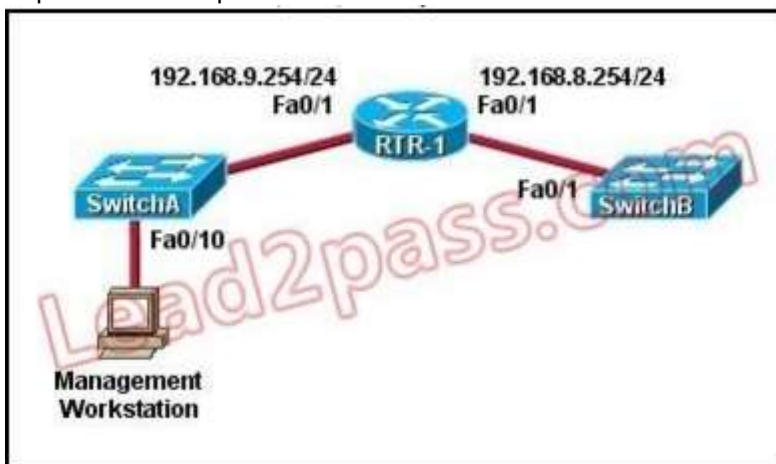

- A. SwitchB(config)# interface FastEthernet 0/1
SwitchB(config-if)# ip address 192.168.8.252 255.255.255.0
SwitchB(config-if)# no shutdown
- B. SwitchB(config)# interface vlan 1
SwitchB(config-if)# ip address 192.168.8.252 255.255.255.0
SwitchB(config-if)# ip default-gateway 192.168.8.254 255.255.255.0
SwitchB(config-if)# no shutdown
- C. SwitchB(config)# ip default-gateway 192.168.8.254
SwitchB(config)# interface vlan 1
SwitchB(config-if)# ip address 192.168.8.252 255.255.255.0
SwitchB(config-if)# no shutdown
- D. SwitchB(config)# ip default-network 192.168.8.254
SwitchB(config)# interface vlan 1
SwitchB(config-if)# ip address 192.168.8.252 255.255.255.0
SwitchB(config-if)# no shutdown
- E. SwitchB(config)# ip route 192.168.8.254 255.255.255.0
SwitchB(config)# interface FastEthernet 0/1
SwitchB(config-if)# ip address 192.168.8.252 255.255.255.0
SwitchB(config-if)# no shutdown

Correct Answer: C

Section: (none)

Explanation

Explanation/Reference:

QUESTION 34

Which of the following are benefits of VLANs? (Choose three.)

- A. They increase the size of collision domains.
- B. They allow logical grouping of users by function.
- C. They can enhance network security.
- D. They increase the size of broadcast domains while decreasing the number of collision domains.
- E. They increase the number of broadcast domains while decreasing the size of the broadcast domains.
- F. They simplify switch administration.

Correct Answer: BCE

Section: (none)

Explanation

Explanation/Reference:

QUESTION 35

What are three benefits of implementing VLANs? (Choose three.)

- A. A higher level of network security can be reached by separating sensitive data traffic from other network traffic.
- B. A more efficient use of bandwidth can be achieved allowing many physical groups to use the same network infrastructure.
- C. A more efficient use of bandwidth can be achieved allowing many logical networks to use the same network infrastructure.
- D. Broadcast storms can be mitigated by increasing the number of broadcast domains, thus reducing their size.
- E. Broadcast storms can be mitigated by decreasing the number of broadcast domains, thus increasing their size.
- F. VLANs make it easier for IT staff to configure new logical groups, because the VLANs all belong to the same broadcast domain.
- G. Port-based VLANs increase switch-port use efficiency, thanks to 802.1Q trunks.

Correct Answer: ACD

Section: (none)

Explanation

Explanation/Reference:

QUESTION 36

Which three statements accurately describe Layer 2 Ethernet switches? (Choose three.)

- A. Spanning Tree Protocol allows switches to automatically share VLAN information.
- B. Establishing VLANs increases the number of broadcast domains.
- C. Switches that are configured with VLANs make forwarding decisions based on both Layer 2 and Layer 3 address information.
- D. Microsegmentation decreases the number of collisions on the network.
- E. In a properly functioning network with redundant switched paths, each switched segment will contain one root bridge with all its ports in the forwarding state. All other switches in that broadcast domain will have only one root port.

F. If a switch receives a frame for an unknown destination, it uses ARP to resolve the address.

Correct Answer: BDE

Section: (none)

Explanation

Explanation/Reference:

QUESTION 37

Which of the following correctly describe steps in the OSI data encapsulation process? (Choose two.)

- A. The transport layer divides a data stream into segments and may add reliability and flow control information.
- B. The data link layer adds physical source and destination addresses and an FCS to the segment.
- C. Packets are created when the network layer encapsulates a frame with source and destination host addresses and protocol-related control information.
- D. Packets are created when the network layer adds Layer 3 addresses and control information to a segment.
- E. The presentation layer translates bits into voltages for transmission across the physical link.

Correct Answer: AD

Section: (none)

Explanation

Explanation/Reference:

QUESTION 38

Which of the following describes the roles of devices in a WAN? (Choose three.)

- A. A CSU/DSU terminates a digital local loop.
- B. A modem terminates a digital local loop.
- C. A CSU/DSU terminates an analog local loop.
- D. A modem terminates an analog local loop.
- E. A router is commonly considered a DTE device.
- F. A router is commonly considered a DCE device.

Correct Answer: ADE

Section: (none)

Explanation

Explanation/Reference:

QUESTION 39

Which interface counter can you use to diagnose a duplex mismatch problem?

- A. no carrier
- B. late collisions
- C. giants
- D. CRC errors
- E. deferred
- F. runts

Correct Answer: B

Section: (none)

Explanation

Explanation/Reference:

QUESTION 40

Which feature can you implement to reserve bandwidth for VoIP calls across the call path?

- A. PQ
- B. CBWFQ
- C. round robin
- D. RSVP

Correct Answer: D

Section: (none)

Explanation

Explanation/Reference:

QUESTION 41

When an interface is configured with PortFast BPDU guard, how does the interface respond when it receives a BPDU?

- A. It continues operating normally.
- B. It goes into a down/down state.
- C. It becomes the root bridge for the configured VLAN.
- D. It goes into an errdisable state.

Correct Answer: D

Section: (none)

Explanation

Explanation/Reference:

QUESTION 42

What are three characteristics of the TCP protocol? (Choose three.)

- A. It uses a single SYN-ACK message to establish a connection.
- B. The connection is established before data is transmitted.
- C. It ensures that all data is transmitted and received by the remote device.
- D. It supports significantly higher transmission speeds than UDP.
- E. It requires applications to determine when data packets must be retransmitted.
- F. It uses separate SYN and ACK messages to establish a connection.

Correct Answer: BCF

Section: (none)

Explanation

Explanation/Reference:

QUESTION 43

Which command can you enter to determine whether serial interface 0/2/0 has been configured using HDLC encapsulation?

- A. router#show platform
- B. router#show interfaces Serial 0/2/0
- C. router#show ip interface s0/2/0
- D. router#show ip interface brief

Correct Answer: B

Section: (none)

Explanation

Explanation/Reference:

QUESTION 44

Which two statements about IPv4 multicast traffic are true? (Choose two.)

- A. It burdens the source host without affecting remote hosts.
- B. It uses a minimum amount of network bandwidth.
- C. It is bandwidth-intensive.
- D. It simultaneously delivers multiple streams of data.
- E. It is the most efficient way to deliver data to multiple receivers.

Correct Answer: DE

Section: (none)

Explanation

Explanation/Reference:

QUESTION 45

What are two benefits of private IPv4 IP addresses? (Choose two.)

- A. They are routed the same as public IP addresses.
- B. They are less costly than public IP addresses.
- C. They can be assigned to devices without Internet connections.
- D. They eliminate the necessity for NAT policies.
- E. They eliminate duplicate IP conflicts.

Correct Answer: BC

Section: (none)

Explanation

Explanation/Reference:

QUESTION 46

What is the authoritative source for an address lookup?

- A. a recursive DNS search
- B. the operating system cache
- C. the ISP local cache
- D. the browser cache

Correct Answer: A
Section: (none)
Explanation

Explanation/Reference:

QUESTION 47

Which command can you enter to verify that a BGP connection to a remote device is established?

- A. show ip bgp summary
- B. show ip community-list
- C. show ip bgp paths
- D. show ip route

Correct Answer: A
Section: (none)
Explanation

Explanation/Reference:

QUESTION 48

During which phase of PPPoE is PPP authentication performed?

- A. the PPP Session phase
- B. Phase 2
- C. the Active Discovery phase
- D. the Authentication phase
- E. Phase 1

Correct Answer: A
Section: (none)
Explanation

Explanation/Reference:

QUESTION 49

Which three circumstances can cause a GRE tunnel to be in an up/down state? (Choose three.)

- A. The tunnel interface IP address is misconfigured.
- B. The tunnel interface is down.
- C. A valid route to the destination address is missing from the routing table.
- D. The tunnel address is routed through the tunnel itself.
- E. The ISP is blocking the traffic.
- F. An ACL is blocking the outbound traffic.

Correct Answer: BCD
Section: (none)
Explanation

Explanation/Reference:

QUESTION 50

Which two statements about using leased lines for your WAN infrastructure are true? (Choose two.)

- A. Leased lines provide inexpensive WAN access.
- B. Leased lines with sufficient bandwidth can avoid latency between endpoints.
- C. Leased lines require little installation and maintenance expertise.
- D. Leased lines provide highly flexible bandwidth scaling.
- E. Multiple leased lines can share a router interface.
- F. Leased lines support up to T1 link speeds.

Correct Answer: CD

Section: (none)

Explanation

Explanation/Reference:

QUESTION 51

Which two statements about wireless LAN controllers are true? (Choose two.)

- A. They can simplify the management and deployment of wireless LANs.
- B. They rely on external firewalls for WLAN security.
- C. They are best suited to smaller wireless networks.
- D. They must be configured through a GUI over HTTP or HTTPS.
- E. They can manage mobility policies at a systemwide level.

Correct Answer: AE

Section: (none)

Explanation

Explanation/Reference:

QUESTION 52

Which two statements about northbound and southbound APIs are true? (Choose two.)

- A. Only southbound APIs allow program control of the network.
- B. Only northbound APIs allow program control of the network.
- C. Only southbound API interfaces use a Service Abstraction Layer.
- D. Only northbound API interfaces use a Service Abstraction Layer.
- E. Both northbound and southbound API interfaces use a Service Abstraction Layer.
- F. Both northbound and southbound APIs allow program control of the network.

Correct Answer: BC

Section: (none)

Explanation

Explanation/Reference:

QUESTION 53

Which command can you enter to set the default route for all traffic to an interface?

- A. router(config)#ip route 0.0.0.0 0.0.0.0 GigabitEthernet0/1
- B. router(config-router)#default-information originate always
- C. router(config)#ip route 0.0.0.0 255.255.255.255 GigabitEthernet0/1
- D. route(config-router)#default-information originate

Correct Answer: A

Section: (none)

Explanation

Explanation/Reference:

QUESTION 54

Which WAN topology is most appropriate for a centrally located server farm with several satellite branches?

- A. star
- B. hub and spoke
- C. point-to-point
- D. full mesh

Correct Answer: B

Section: (none)

Explanation

Explanation/Reference:

In a Hub-and-spoke Site-to-Site Wide Area Network (WAN) network topology, one physical site act as Hub (Example, Main Office), while other physical sites act as spokes. Spoke sites are connected to each other via Hub site. In Huband-spoke Wide Area Network (WAN) topology, the network communication between two spokes always travels through the hub.

QUESTION 55

Which function allows EIGRP peers to receive notice of implementing topology changes?

- A. successors
- B. advertised changes
- C. goodbye messages
- D. expiration of the hold timer

Correct Answer: C

Section: (none)

Explanation

Explanation/Reference:

QUESTION 56

If you configure syslog messages without specifying the logging trap level, which log messages will the router send?

- A. informational messages only
- B. warning and error conditions only
- C. normal but significant conditions only
- D. error conditions only
- E. all levels except debugging

Correct Answer: E
Section: (none)
Explanation

Explanation/Reference:

QUESTION 57

Which three options are benefits of using TACACS+ on a device? (Choose three)

- A. It ensures that user activity is untraceable.
- B. It provides a secure accounting facility on the device.
- C. device-administration packets are encrypted in their entirety.
- D. It allows the user to remotely access devices from other vendors.
- E. It allows the users to be authenticated against a remote server.
- F. It supports access-level authorization for commands.

Correct Answer: CEF
Section: (none)
Explanation

Explanation/Reference:

http://tacacs.net/docs/TACACS_Advantages.pdf

<http://www.cisco.com/c/en/us/support/docs/security-vpn/remote-authentication-dial-user-serviceradius/13838-10.html>

QUESTION 58

What layer of the OSI Model is included in TCP/IP Model's INTERNET layer?

- A. Application
- B. Session
- C. Data Link
- D. Presentation
- E. Network

Correct Answer: E
Section: (none)
Explanation

Explanation/Reference:

NOT SURE ABOUT THE CHOICES. NOT SURE ABOUT THE QUESTION EITHER.

QUESTION 59

Which two of these are characteristics of the 802.1Q protocol? (Choose two.)

- A. It is used exclusively for tagging VLAN frames and does not address network convergence following switched network topology changes.
- B. It modifies the 802.3 frame header, and thus requires that the FCS be recomputed.
- C. It is a Layer 2 messaging protocol which maintains VLAN configurations across networks.
- D. It includes an 8-bit field which specifies the priority of a frame.
- E. It is a trunking protocol capable of carrying untagged frames.

Correct Answer: BE
Section: (none)

Explanation

Explanation/Reference:

QUESTION 60

Which two features can dynamically assign IPv6 addresses? (Choose two.)

- A. IPv6 stateless autoconfiguration
- B. DHCP
- C. NHRP
- D. IPv6 stateful autoconfiguration
- E. ISATAP tunneling

Correct Answer: AB

Section: (none)

Explanation

Explanation/Reference:

QUESTION 61

A security administrator wants to profile endpoints and gain visibility into attempted authentications. Which 802.1x mode allows these actions?

- A. Monitor mode
- B. High-Security mode
- C. Low-impact mode
- D. Closed mode

Correct Answer: A

Section: (none)

Explanation

Explanation/Reference:

QUESTION 62

How to verify strong and secured SSH connection?

- A. `ssh -v 1 -l admin 10.1.1.1`
- B. `ssh -v 2 -l admin 10.1.1.1`
- C. `ssh -l admin 10.1.1.1`
- D. `ssh -v 2 admin 10.1.1.1`

Correct Answer: B

Section: (none)

Explanation

Explanation/Reference:

Sorry for the question but they said it was something like that.

QUESTION 63

Which statement about RADIUS security is true?

- A. It supports EAP authentication for connecting to wireless networks.
- B. It provides encrypted multiprotocol support.
- C. Device-administration packets are encrypted in their entirety.
- D. It ensures that user activity is fully anonymous.

Correct Answer: A

Section: (none)

Explanation

Explanation/Reference:

QUESTION 64

If you are configuring syslog messages specifying 'logging trap warning', which log messages will the router send?

- A. 0-4
- B. 0-5
- C. 0-2
- D. 0-6
- E. 0-1

Correct Answer: A

Section: (none)

Explanation

Explanation/Reference:

0 emergencies System is unusable
1 alerts Immediate action is needed
2 critical Critical conditions exist
3 errors Error conditions exist
4 warnings Warning conditions exist
5 notification Normal, but significant, conditions exist
6 informational Informational messages
7 debugging Debugging messages

QUESTION 65

What is the correct command for floating static ipv6 route?

- A. ipv6 route 2001:DB8::/32 serial 2/0 201
- B. ipv6 route 2001:DB8::/32 serial 2/0 1
- C. N/A
- D. N/A

Correct Answer: A

Section: (none)

Explanation

Explanation/Reference:

QUESTION 66

What is true about Ethernet? (Choose Two.)

- A. 802.2 Protocol

- B. 802.3 Protocol
- C. 10BaseT half duplex
- D. CSMA/CD Stops transmitting when congestion occurs
- E. CSMA/CA Stops transmitting when congestion occurs

Correct Answer: BD

Section: (none)

Explanation

Explanation/Reference:

<http://www.ieee802.org/3/>

CSMA/CD - It uses a carrier sensing scheme in which a transmitting station detects collisions by sensing transmissions from other stations while transmitting a frame. When this collision condition is detected, the station stops transmitting that frame.

QUESTION 67

What IP SLA ICMP Echo measures?

- A. Packet loss
- B. Congestion
- C. Hop-by-hop "something"
- D. -ANOTHER OPTION-
- E. -ANOTHER OPTION-

Correct Answer: A

Section: (none)

Explanation

Explanation/Reference:

There is no RRT (Round-trip time) in the choices @Mik said.

QUESTION 68

What are types of IPv6 static routes? (Choose Three.)

- A. Recursive routes
- B. Directly connected routes
- C. Fully specified routes
- D. Advertised routes
- E. Virtual links
- F. Redistributed routes

Correct Answer: ABC

Section: (none)

Explanation

Explanation/Reference:

<http://ipcisco.com/ipv6-static-routes-for-cisco-routers/>

<http://www.orbit-computer-solutions.com/ipv6-static-and-default-route-how-to-configure-ipv6-static-and-default-route/>

QUESTION 69

How to configure RIPv2? (Choose Two.)

- A. Enable RIP
- B. Connect RIP to WAN interface

- C. Enable auto-summary
- D. Enable authentication
- E. -ANOTHER OPTION-

Correct Answer: AC

Section: (none)

Explanation

Explanation/Reference:

C because we can enable or disable auto-summary in rips.

QUESTION 70

What is the status of port-channel if LACP is misconfigured?

- A. Forwarding
- B. Enabled
- C. Disabled
- D. Errdisabled

Correct Answer: C

Section: (none)

Explanation

Explanation/Reference:

QUESTION 71

What is true about DTP? (Choose Three.)

- A. Layer 2 protocol
- B. Layer 3 protocol
- C. Proprietary protocol
- D. enabled by default
- E. disabled by default

Correct Answer: ACD

Section: (none)

Explanation

Explanation/Reference:

https://en.wikipedia.org/wiki/Dynamic_Trunking_Protocol

QUESTION 72

How to create a trunk port and allow VLAN 20? (Choose Three.)

- A. switchport trunk encapsulation dot1q
- B. switchport mode trunk
- C. switchport trunk allowed vlan 20
- D. switchport trunk native vlan 20
- E. -ANOTHER OPTION-

Correct Answer: ABC

Section: (none)

Explanation

Explanation/Reference:

QUESTION 73

What 8-bit field exists in IP packet for QoS?

- A. Tos Field
- B. DSCP
- C. IP Precedence
- D. Cos
- E. -ANOTHER OPTION-

Correct Answer: A

Section: (none)

Explanation

Explanation/Reference:

<http://flylib.com/books/2/686/1/html/2/images/1587051990/graphics/13fig01.gif>

QUESTION 74

What feature uses a random time to re-sent a frame?

- A. CSMA/CA
- B. -ANOTHER OPTION-
- C. -ANOTHER OPTION-
- D. CSMA/CD

Correct Answer: D

Section: (none)

Explanation

Explanation/Reference:

QUESTION 75

Which mode is compatible with Trunk, Access, and desirable ports?

- A. Trunk Ports
- B. Access Ports
- C. Dynamic Auto
- D. Dynamic Desirable

Correct Answer: C

Section: (none)

Explanation

Explanation/Reference:

The 'dynamic auto' will configure the port to accept incoming negotiation and will accept becoming either a trunk or an access port. Dynamic Auto allows the port to negotiate DTP (Dynamic Trunking Protocol) if the other side is set to trunk or desirable. Otherwise it will become an access port.

QUESTION 76

If you configure syslog messages without specifying the logging trap level, which log messages will the router send?

- A. 0-4
- B. 0-5
- C. 0-2
- D. 0-6
- E. 0-1

Correct Answer: D

Section: (none)

Explanation

Explanation/Reference:

Router(config)# logging trap level - Specifies the kind of messages, by severity level, to be sent to the syslog server. The default is informational (6) and lower (0 – 6). The possible values for level are as follows:
Emergency: 0

Alert: 1

Critical: 2

Error: 3

Warning: 4

Notice: 5

Informational: 6

Debug: 7

QUESTION 77

Which command can you execute to set the user inactivity timer to 10 seconds?

- A. SW1(config-line)#exec-timeout 0 10
- B. SW1(config-line)#exec-timeout 10
- C. SW1(config-line)#absolute-timeout 0 10
- D. SW1(config-line)#absolute-timeout 10

Correct Answer: A

Section: (none)

Explanation

Explanation/Reference:

QUESTION 78

Which standards-based First Hop Redundancy Protocol is a Cisco supported alternative to Hot Standby Router Protocol?

- A. VRRP
- B. GLBP
- C. TFTP
- D. DHCP

Correct Answer: A

Section: (none)

Explanation

Explanation/Reference:

QUESTION 79

Two hosts are attached to a switch with the default configuration. Which statement about the configuration is true?

- A. IP routing must be enabled to allow the two hosts to communicate.
- B. The two hosts are in the same broadcast domain.
- C. The switch must be configured with a VLAN to allow the two hosts to communicate.
- D. Port security prevents the hosts from connecting to the switch.

Correct Answer: B

Section: (none)

Explanation

Explanation/Reference:

QUESTION 80

If there are 3 hosts connected in one port of a switch and two other hosts connected in another port, how many collision domains are present on the router?

- A. 5
- B. 2
- C. 3
- D. 4

Correct Answer: B

Section: (none)

Explanation

Explanation/Reference:

QUESTION 81

What are three parts of an IPv6 global unicast address? (Choose three.)

- A. an interface ID that is used to identify the local host on the network.
- B. an interface ID that is used to identify the local network for a particular host.
- C. a subnet ID that is used to identify networks inside of the local enterprise site
- D. a global routing prefix that is used to identify the network portion of the address that has been provided by an ISP
- E. a global routing prefix that is used to identify the portion of the network address provided by a local administrator

Correct Answer: ACD

Section: (none)

Explanation

Explanation/Reference:

QUESTION 82

You have been asked to come up with a subnet mask that will allow all three web servers to be on the same network while providing the maximum number of subnets. Which network address and subnet mask meet this requirement?

- A. 192.168.252.0 255.255.255.252
- B. 192.168.252.8 255.255.255.248
- C. 192.168.252.8 255.255.255.252

- D. 192.168.252.16 255.255.255.240
- E. 192.168.252.16 255.255.255.252

Correct Answer: B

Section: (none)

Explanation

Explanation/Reference:

QUESTION 83

What parameter can be different on ports within an EtherChannel?

- A. speed
- B. DTP negotiation settings
- C. trunk encapsulation
- D. duplex

Correct Answer: B

Section: (none)

Explanation

Explanation/Reference:

QUESTION 84

Which two statements about IPv6 router advertisement messages are true? (Choose two.)

- A. They use ICMPv6 type 134.
- B. The advertised prefix length must be 64 bits.
- C. The advertised prefix length must be 48 bits.
- D. They are sourced from the configured IPv6 interface address.
- E. Their destination is always the link-local address of the neighboring node.

Correct Answer: AB

Section: (none)

Explanation

Explanation/Reference:

QUESTION 85

Which spanning-tree protocol rides on top of another spanning-tree protocol?

- A. MSTP
- B. RSTP
- C. PVST+
- D. Mono Spanning Tree

Correct Answer: A

Section: (none)

Explanation

Explanation/Reference:

QUESTION 86

A network administrator needs to configure port security on a switch. Which two statements are true? (Choose two.)

- A. The network administrator can apply port security to dynamic access ports.
- B. The network administrator can apply port security to EtherChannels.
- C. The sticky learning feature allows the addition of dynamically learned addresses to the running configuration.
- D. When dynamic MAC address learning is enabled on an interface, the switch can learn new addresses, up to the maximum defined.
- E. The network administrator can configure static secure or sticky secure MAC addresses in the voice VLAN

Correct Answer: CD

Section: (none)

Explanation

Explanation/Reference:

QUESTION 87

Which switching method duplicates the first six bytes of a frame before making a switching decision?

- A. fragment-free switching
- B. store-and-forward switching
- C. cut-through switching
- D. ASIC switching

Correct Answer: C

Section: (none)

Explanation

Explanation/Reference:

QUESTION 88

Which logging command can enable administrators to correlate syslog messages with millisecond precision?

- A. no logging console
- B. logging buffered 4
- C. no logging monitor
- D. service timestamps log datetime msec
- E. logging host 10.2.0.21

Correct Answer: D

Section: (none)

Explanation

Explanation/Reference:

QUESTION 89

Which three statements about link-state routing are true? (Choose three.)

- A. OSPF is a link-state protocol.
- B. Updates are sent to a broadcast address.
- C. It uses split horizon.
- D. Routes are updated when a change in topology occurs.
- E. RIP is a link-state protocol.
- F. Updates are sent to a multicast address by default.

Correct Answer: ADF

Section: (none)

Explanation

Explanation/Reference:

QUESTION 90

Which command can you enter to determine whether a switch is operating in trunking mode?

- A. show ip interface brief
- B. show vlan
- C. show interfaces
- D. show interface switchport

Correct Answer: D

Section: (none)

Explanation

Explanation/Reference:

QUESTION 91

Which command can you enter to view the ports that are assigned to VLAN 20?

- A. Switch#show ip interface vlan 20
- B. Switch#show vlan id 20
- C. Switch#show ip interface brief
- D. Switch#show interface vlan 20

Correct Answer: B

Section: (none)

Explanation

Explanation/Reference:

QUESTION 92

In which two formats can the IPv6 address fd15:0db8:0000:0000:0700:0003:400F:572B be written? (Choose two.)

- A. fd15:0db8:0000:0000:700:3:400F:527B
- B. fd15::db8::700:3:400F:527B
- C. fd15:db8:0::700:3:4F:527B
- D. fd15:0db8::7:3:4F:527B
- E. fd15:db8::700:3:400F:572B

Correct Answer: AE

Section: (none)

Explanation

Explanation/Reference:

QUESTION 93

Which function of the IP SLAs ICMP jitter operation can you use to determine whether a VoIP issue is caused by excessive end-to-end time?

- A. packet loss
- B. jitter
- C. successive packet loss
- D. round-trip time latency

Correct Answer: D

Section: (none)

Explanation

Explanation/Reference:

QUESTION 94

Refer to the exhibit.

```
00:00:39: %LINEPROTO-5-UPDOWN: Line protocol on Interface Vlan1, changed state to down
00:00:40: %SPANNTREE-5-EXTENDED_SYSID: Extended SysId enabled for type vlan
00:00:42: %SYS-5-CONFIG_I: Configured from memory by console
00:00:42: %SYS-5-RESTART: System restarted --
Cisco IOS Software, C2960 Software (C2960-LANBASEK9-M), Version 12.2(25)SEE2, RELEASE SOFTWARE (fc.1)
Copyright (c) 1986-2006 by Cisco Systems, Inc.
Compiled Fri 28-Jul-06 11:57 by yenanh
00:00:44: %LINK-5-CHANGED: Interface Vlan1, changed state to administratively down
00:00:44: %LINK-3-UPDOWN: Interface FastEthernet0/1, changed state to up
00:00:44: %LINK-3-UPDOWN: Interface FastEthernet0/2, changed state to up
00:00:44: %LINK-3-UPDOWN: Interface FastEthernet0/11, changed state to up
00:00:45: %LINEPROTO-5-UPDOWN: Line protocol on Interface FastEthernet0/1, changed state to up
00:00:45: %LINEPROTO-5-UPDOWN: Line protocol on Interface FastEthernet0/2, changed state to up
00:00:45: %LINEPROTO-5-UPDOWN: Line protocol on Interface FastEthernet0/11, changed state to up
00:00:48: %LINK-3-UPDOWN: Interface FastEthernet0/12, changed state to up
00:00:49: %LINEPROTO-5-UPDOWN: Line protocol on Interface FastEthernet0/12, changed state to up
```

Which of these statements correctly describes the state of the switch once the boot process has been completed?

- A. A. The switch will need a different IOS code in order to support VLANs and STP.
- B. Remote access management of this switch will not be possible without configuration change.
- C. As FastEthernet0/12 will be the last to come up, it will be blocked by STP.
- D. More VLANs will need to be created for this switch.

Correct Answer: B

Section: (none)

Explanation

Explanation/Reference:

QUESTION 95

Refer to the exhibit.

The network administrator normally establishes a Telnet session with the switch from host A. However, host A is unavailable. The administrator's attempt to telnet to the switch from host B fails, but pings to the other two hosts are successful. What is the issue?

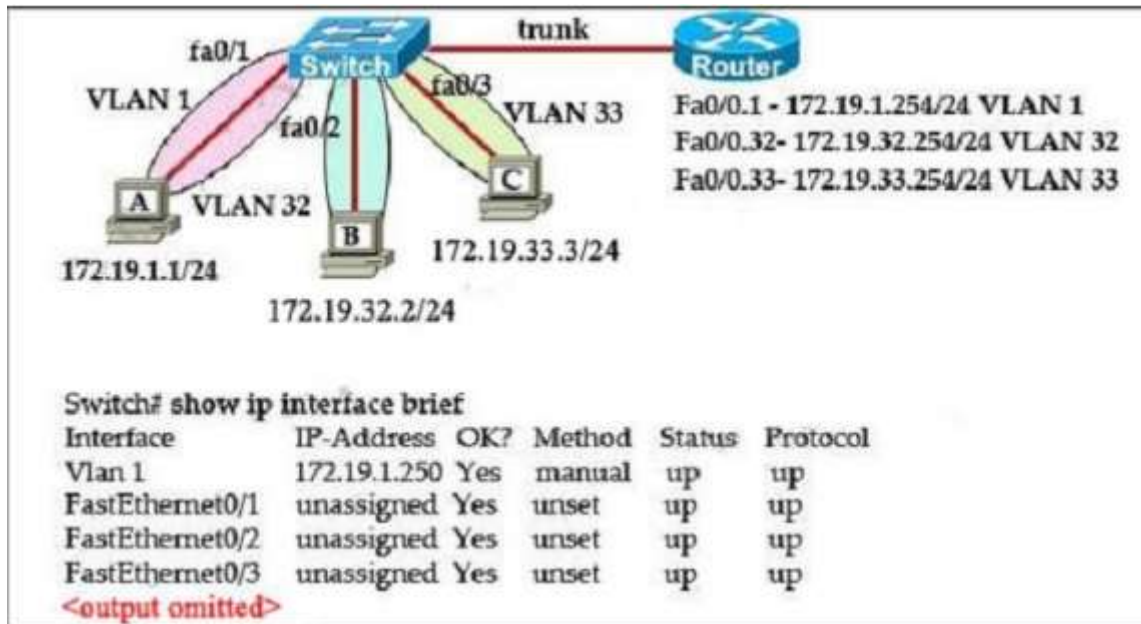

- A. The switch interfaces need the appropriate IP addresses assigned.
- B. Host B and the switch need to be in the same subnet.
- C. The switch needs an appropriate default gateway assigned.
- D. The switch interface connected to the router is down.
- E. Host B needs to be assigned an IP address in VLAN 1.

Correct Answer: C

Section: (none)

Explanation

Explanation/Reference:

QUESTION 96

Which condition does the err-disabled status indicate on an Ethernet interface?

- A. There is a duplex mismatch.
- B. The device at the other end of the connection is powered off.
- C. The serial interface is disabled.
- D. The interface is configured with the shutdown command.
- E. Port security has disabled the interface.
- F. The interface is fully functioning.

Correct Answer: E
Section: (none)
Explanation

Explanation/Reference:

QUESTION 97

Which two correctly describe steps in the OSI data encapsulation process? (Choose two.)

- A. The presentation layer translates bits into voltages for transmission across the physical link.
- B. The data link layer adds physical source and destination addresses and an FCS to the segment.
- C. Packets are created when the network layer adds Layer 3 addresses and control information to a segment.
- D. Packets are created when the network layer encapsulates a frame with source and destination host addresses and protocol-related control information.
- E. The transport layer divides a data stream into segments and may add reliability and flow control information.

Correct Answer: CE
Section: (none)
Explanation

Explanation/Reference:

QUESTION 98

Refer to the exhibit

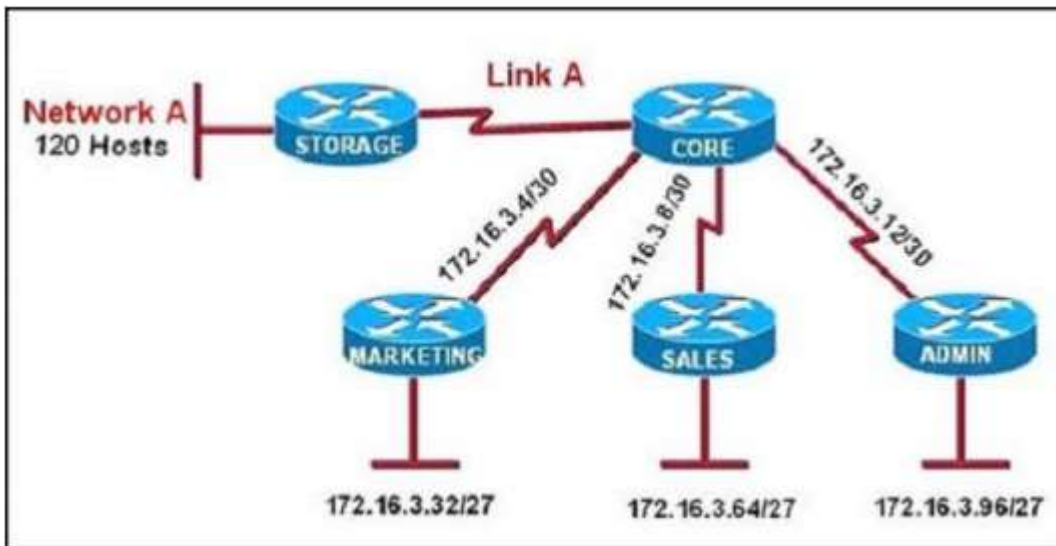

All of the routers in the network are configured with the ip subnet-zero command. Which network addresses should be used for Link A and Network A? (Choose two.)

- A. Link A – 172.16.3.0/30
- B. Link A – 172.16.3.112/30
- C. Network A – 172.16.3.48/26
- D. Network A – 172.16.3.128/25
- E. Link A – 172.16.3.40/30

F. Network A – 172.16.3.192/26

Correct Answer: AD

Section: (none)

Explanation

Explanation/Reference:

QUESTION 99

Which type of device can be replaced by the use of subinterfaces for VLAN routing

- A. Layer 2 bridge
- B. Layer 2 switch
- C. Layer 3 switch
- D. router

Correct Answer: C

Section: (none)

Explanation

Explanation/Reference:

QUESTION 100

Which statement about LLDP is true?

- A. It is a Cisco proprietary protocol.
- B. It is configured in global configuration mode.
- C. The LLDP update frequency is a fixed value.
- D. It runs over the transport layer.

Correct Answer: B

Section: (none)

Explanation

Explanation/Reference:

QUESTION 101

If the primary root bridge experiences a power loss, which switch takes over?

- A. switch 0040.0BC0.90C5
- B. switch 00E0.F90B.6BE3
- C. switch 0004.9A1A.C182
- D. switch 00E0.F726.3DC6

Correct Answer: C

Section: (none)

Explanation

Explanation/Reference:

QUESTION 102

A network administrator is troubleshooting an EIGRP problem on a router and needs to confirm the IP

addresses of the devices with which the router has established adjacency. The retransmit interval and the queue counts for the adjacent routers also need to be checked. What command will display the required information?

- A. Router# show ip eigrp neighbors
- B. Router# show ip eigrp interfaces
- C. Router# show ip eigrp adjacency
- D. Router# show ip eigrp topology

Correct Answer: A

Section: (none)

Explanation

Explanation/Reference:

QUESTION 103

Which three statements about IPv6 prefixes are true? (Choose three.)

- A. FEC0::/10 is used for IPv6 broadcast.
- B. FC00::/7 is used in private networks.
- C. FE80::/8 is used for link-local unicast.
- D. FE80::/10 is used for link-local unicast.
- E. 2001::1/127 is used for loopback addresses.
- F. FF00::/8 is used for IPv6 multicast.

Correct Answer: BDF

Section: (none)

Explanation

Explanation/Reference:

QUESTION 104

Which command can you enter to display duplicate IP addresses that the DHCP server assigns?

- A. show ip dhcp conflict 10.0.2.12
- B. show ip dhcp database 10.0.2.12
- C. show ip dhcp server statistics
- D. show ip dhcp binding 10.0.2.12

Correct Answer: A

Section: (none)

Explanation

Explanation/Reference:

QUESTION 105

Which three ports will be STP designated ports if all the links are operating at the same bandwidth? (Choose three.)

- A. Switch B - Fa0/0
- B. Switch A - Fa0/1

- C. Switch B - Fa0/1
- D. Switch C - Fa0/1
- E. Switch A - Fa0/0
- F. Switch C - Fa0/0

Correct Answer: ABC

Section: (none)

Explanation

Explanation/Reference:

QUESTION 106

Refer to the exhibit

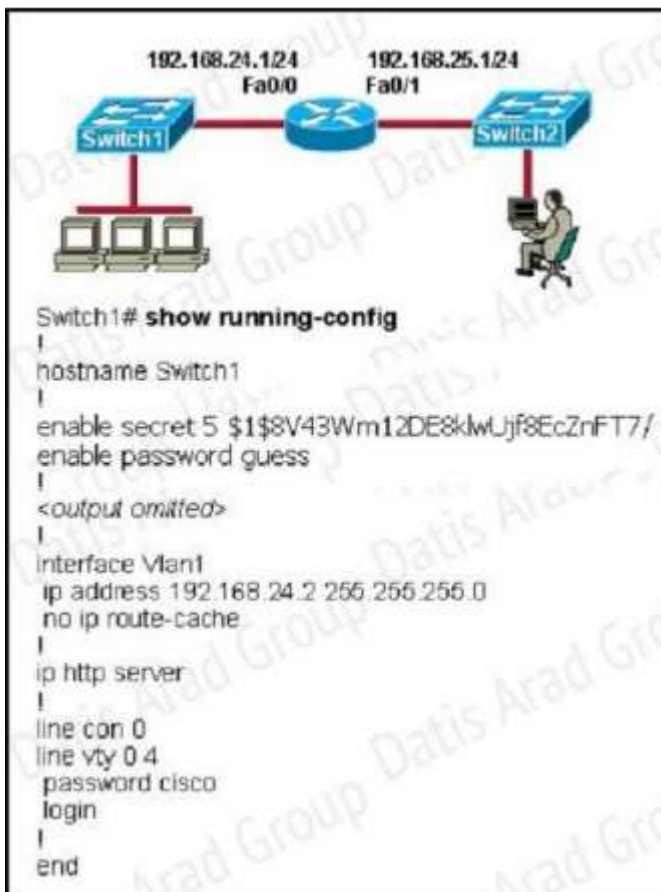

The network administrator cannot connect to Switch 1 over a Telnet session, although the hosts attached to Switch1 can ping the interface Fa0/0 of the router. Given the information in the graphic and assuming that the router and Switch2 are configured properly, which of the following commands should be issued on Switch1 to correct this problem?

- A. Switch1(config)# ip default-gateway 192.168.24.1
- B. Switch1(config)# interface fa0/1Switch1(config-if)# switchport mode trunk
- C. Switch1(config)# line con0Switch1(config-line)# password ciscoSwitch1(config-line)# login
- D. Switch1(config)# interface fa0/1Switch1(config-if)# ip address 192.168.24.3 255.255.255.0

E. Switch1(config)# interface fa0/1Switch1(config-if)# duplex fullSwitch1(config-if)# speed 100

Correct Answer: A

Section: (none)

Explanation

Explanation/Reference:

QUESTION 107

Refer to the exhibit.

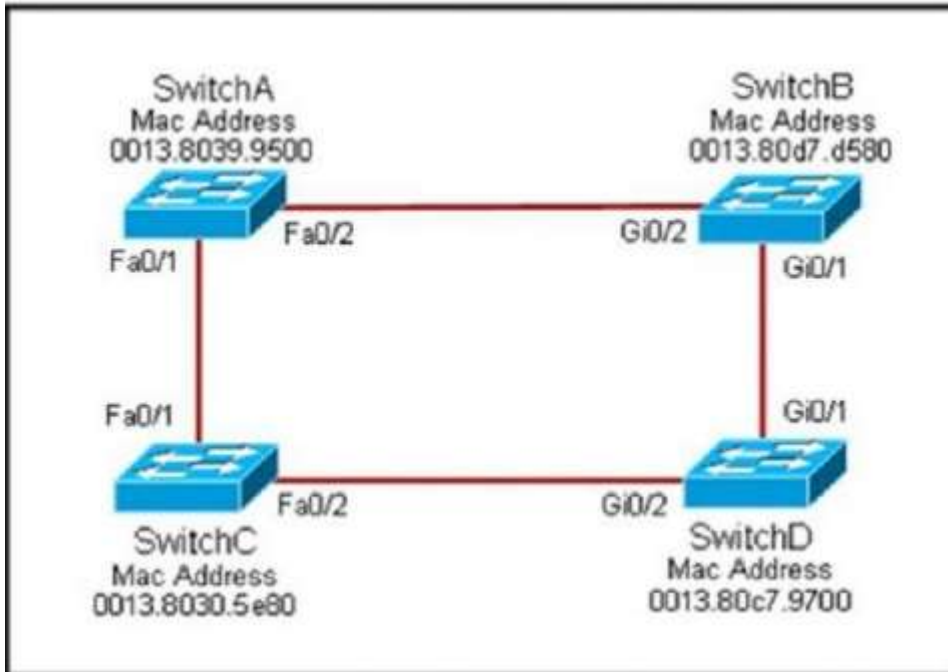

Each of these four switches has been configured with a hostname, as well as being configured to run RSTP. No other configuration changes have been made. Which three of these show the correct RSTP port roles for the indicated switches and interfaces? (Choose three.)

- A. SwitchD, Gi0/2, root
- B. SwitchA, Fa0/2, designated
- C. SwitchB, Gi0/1, designated
- D. SwitchA, Fa0/1, root
- E. SwitchB, Gi0/2, root
- F. SwitchC, Fa0/2, root

Correct Answer: ABD

Section: (none)

Explanation

Explanation/Reference:

QUESTION 108

Which feature builds a FIB and an adjacency table to expedite packet forwarding?

- A. cut through
- B. fast switching
- C. process switching
- D. Cisco Express Forwarding

Correct Answer: D

Section: (none)

Explanation

Explanation/Reference:

QUESTION 109

Which command can you enter to verify that a 128-bit address is live and responding?

- A. traceroute
- B. telnet
- C. ping
- D. show ipv6

Correct Answer: C

Section: (none)

Explanation

Explanation/Reference:

QUESTION 110

What are two reasons that duplex mismatches can be difficult to diagnose? (Choose two.)

- A. The interface displays a connected (up/up) state even when the duplex settings are mismatched.
- B. 1-Gbps interfaces are full-duplex by default.
- C. Full-duplex interfaces use CSMA/CD logic, so mismatches may be disguised by collisions.
- D. The symptoms of a duplex mismatch may be intermittent.
- E. Autonegotiation is disabled.

Correct Answer: AD

Section: (none)

Explanation

Explanation/Reference:

QUESTION 111

Which condition indicates that service password-encryption is enabled?

- A. The local username password is in clear text in the configuration.
- B. The enable secret is in clear text in the configuration.
- C. The local username password is encrypted in the configuration.
- D. The enable secret is encrypted in the configuration.

Correct Answer: C

Section: (none)

Explanation

Explanation/Reference:

QUESTION 112

Which protocol advertises a virtual IP address to facilitate transparent failover of a Cisco routing device?

- A. FHRP
- B. DHCP
- C. RSMLT
- D. ESRP

Correct Answer: A

Section: (none)

Explanation

Explanation/Reference:

QUESTION 113

What is the correct routing match to reach 172.16.1.5/32?

- A. 172.16.1.0/26
- B. 172.16.1.0/25
- C. 172.16.1.0/24
- D. the default route

Correct Answer: A

Section: (none)

Explanation

Explanation/Reference:

QUESTION 114

Which layer in the OSI reference model is responsible for determining the availability of the receiving program and checking to see if enough resources exist for that communication?

- A. transport
- B. network
- C. presentation
- D. session
- E. application

Correct Answer: E

Section: (none)

Explanation

Explanation/Reference:

QUESTION 115

What is the purpose of the POST operation on a router?

- A. determine whether additional hardware has been added

- B. locate an IOS image for booting
- C. enable a TFTP server
- D. set the configuration register

Correct Answer: A

Section: (none)

Explanation

Explanation/Reference:

QUESTION 116

Which protocol is the Cisco proprietary implementation of FHRP?

- A. HSRP
- B. VRRP
- C. GLBP
- D. CARP

Correct Answer: A

Section: (none)

Explanation

Explanation/Reference:

QUESTION 117

Which three characteristics are representative of a link-state routing protocol? (Choose three.)

- A. provides common view of entire topology
- B. exchanges routing tables with neighbors
- C. calculates shortest path
- D. utilizes event-triggered updates
- E. utilizes frequent periodic updates

Correct Answer: ACD

Section: (none)

Explanation

Explanation/Reference:

QUESTION 118

Which part of the PPPoE server configuration contains the information used to assign an IP address to a PPPoE client?

- A. virtual-template interface
- B. DHCP
- C. dialer interface
- D. AAA authentication

Correct Answer: A

Section: (none)

Explanation

Explanation/Reference:

QUESTION 119

Drag and drop the correct address space on the left to the IPv6 multicast feature or protocol on the right.

FF02::5	All nodes of Link Local
FF02::A	All EIGRPv3 Routers
FF02::D	All OSPFv3 Designated Routers
FF02::1	All PIM Routers
FF05::2	All OSPFv3 Routers
FF02::6	All Routers of site local

Select and Place:

Drag and drop the correct address space on the left to the IPv6 multicast feature or protocol on the right.

FF02::5	All nodes of Link Local
FF02::A	All EIGRPv3 Routers
FF02::D	All OSPFv3 Designated Routers
FF02::1	All PIM Routers
FF05::2	All OSPFv3 Routers
FF02::6	All Routers of site local

Correct Answer:

Drag and drop the correct address space on the left to the IPv6 multicast feature or protocol on the right.	
	FF02::1
	FF02::A
	FF02::6
	FF02::D
	FF02::5
	FF05::2

Section: (none)

Explanation

Explanation/Reference:

- FF02::1 ----- All Nodes (link-local)
- FF02::5 ----- OSPFv3 Routers
- FF02::6 ----- OSPFv3 Designated Routers
- FF02::A ----- EIGRPv3 Routers
- FF02::D ----- PIM Routers
- FF05::2 ----- All Routers (site-local)

QUESTION 120

Which three statements about RSTP are true? (Choose three.)

- A. RSTP significantly reduces topology reconverging time after a link failure.
- B. RSTP expands the STP port roles by adding the alternate and backup roles.
- C. RSTP port states are blocking, discarding, learning, or forwarding.
- D. RSTP provides a faster transition to the forwarding state on point-to-point links than STP does.
- E. RSTP also uses the STP proposal-agreement sequence.
- F. RSTP uses the same timer-based process as STP on point-to-point links

Correct Answer: ABD

Section: (none)

Explanation

Explanation/Reference:

QUESTION 121

What are two benefits of using NAT? (Choose two.)

- A. NAT facilitates end-to-end communication when IPsec is enabled.
- B. NAT eliminates the need to re-address all hosts that require external access.
- C. NAT conserves addresses through host MAC-level multiplexing.
- D. Dynamic NAT facilitates connections from the outside of the network.

- E. NAT accelerates the routing process because no modifications are made on the packets.
- F. NAT protects network security because private networks are not advertised.

Correct Answer: BF

Section: (none)

Explanation

Explanation/Reference:

QUESTION 122

Which two commands correctly verify whether port security has been configured on port FastEthernet 0/12 on a switch? (Choose two.)

- A. SW1#show port-secure interface FastEthernet 0/12
- B. SW1#show switchport port-secure interface FastEthernet 0/12
- C. SW1#show running-config
- D. SW1#show port-security interface FastEthernet 0/12
- E. SW1#show switchport port-security interface FastEthernet 0/12

Correct Answer: CD

Section: (none)

Explanation

Explanation/Reference:

QUESTION 123

Refer to the exhibit. Given this output for SwitchC, what should the network administrator's next action be?

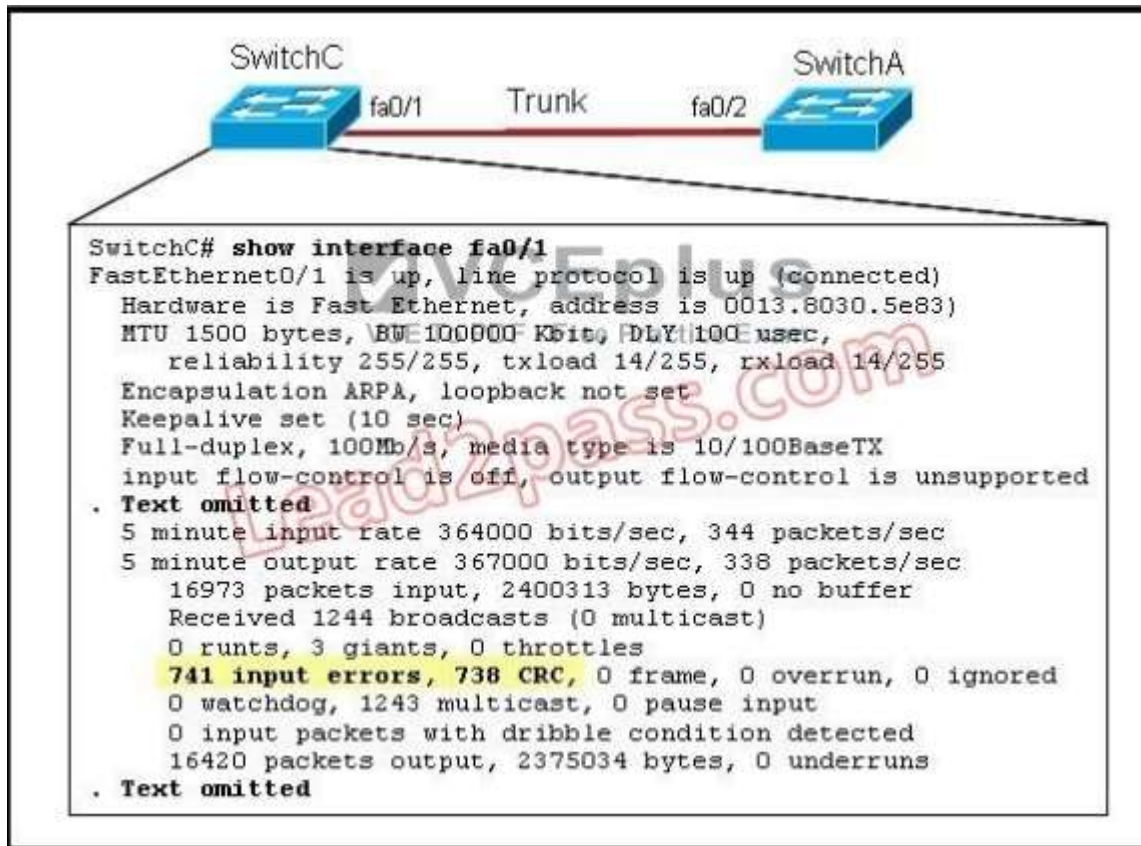

- A. Check the trunk encapsulation mode for SwitchC's fa0/1 port.
- B. Check the duplex mode for SwitchC's fa0/1 port.
- C. Check the duplex mode for SwitchA's fa0/2 port.
- D. Check the trunk encapsulation mode for SwitchA's fa0/2 port

Correct Answer: C

Section: (none)

Explanation

Explanation/Reference:

QUESTION 124

Which statement is correct regarding the operation of DHCP?

- A. A DHCP client uses a ping to detect address conflicts.
- B. A DHCP server uses a gratuitous ARP to detect DHCP clients.
- C. A DHCP client uses a gratuitous ARP to detect a DHCP server.
- D. If an address conflict is detected, the address is removed from the pool and an administrator must resolve the conflict.
- E. If an address conflict is detected, the address is removed from the pool for an amount of time configurable by the administrator.
- F. If an address conflict is detected, the address is removed from the pool and will not be reused until the server is rebooted.

Correct Answer: D

Section: (none)

Explanation

Explanation/Reference:

QUESTION 125

Which two statements about using the CHAP authentication mechanism in a PPP link are true?
(Choose two.)

- A. CHAP uses a two-way handshake.
- B. CHAP uses a three-way handshake.
- C. CHAP authentication periodically occurs after link establishment.
- D. CHAP authentication passwords are sent in plaintext.
- E. CHAP authentication is performed only upon link establishment.
- F. CHAP has no protection from playback attacks.

Correct Answer: BC

Section: (none)

Explanation

Explanation/Reference:

QUESTION 126

Refer to the exhibit. Switch port FastEthernet 0/24 on ALSwitch1 will be used to create an IEEE 802.1Q-compliant trunk to another switch. Based on the output shown, what is the reason the trunk does not form, even though the proper cabling has been attached?

```
ALSwitch1# show running-config
«output omitted»
interface FastEthernet0/24 no ip address
«output omitted»
ALSwitch1# show interfaces FastEthernet0/24 switchport
Name: Fa0/24
Switchport: Enable
Administrative Mode: static access
Operation Mode: static access
Administrative Trunking Encapsulation: dot1q
Operation Trunking Encapsulation: native
Negotiation of Trunking: Off
Access Mode VLAN: 1 (default)
Trunking Native Mode VLAN: 1 (default)
Voice VLAN: none
Administrative private-vlan host-association: none
Administrative private-vlan mapping: none
Operation private-vlan: none
Trunking VLANs Enabled: ALL
Pruning VLANs Enabled: 2-1001
Capture Mode Disabled
Capture VLANs Allowed: ALL

Protected: false

Voice VLAN: none (Inactive)
Appliance trust: none
```

- A. VLANs have not been created yet.
- B. An IP address must be configured for the port.
- C. The port is currently configured for access mode.
- D. The correct encapsulation type has not been configured.
- E. The no shutdown command has not been entered for the port.

Correct Answer: C

Section: (none)

Explanation

Explanation/Reference:

QUESTION 127

Refer to the exhibit. A junior network administrator was given the task of configuring port security on SwitchA to allow only PC_A to access the switched network through port fa0/1. If any other device is detected, the port is to drop frames from this device. The administrator configured the interface and tested it with successful pings from PC_A to RouterA, and then observes the output from these two show commands. Which two of these changes are necessary for SwitchA to meet the requirements? (Choose two.)

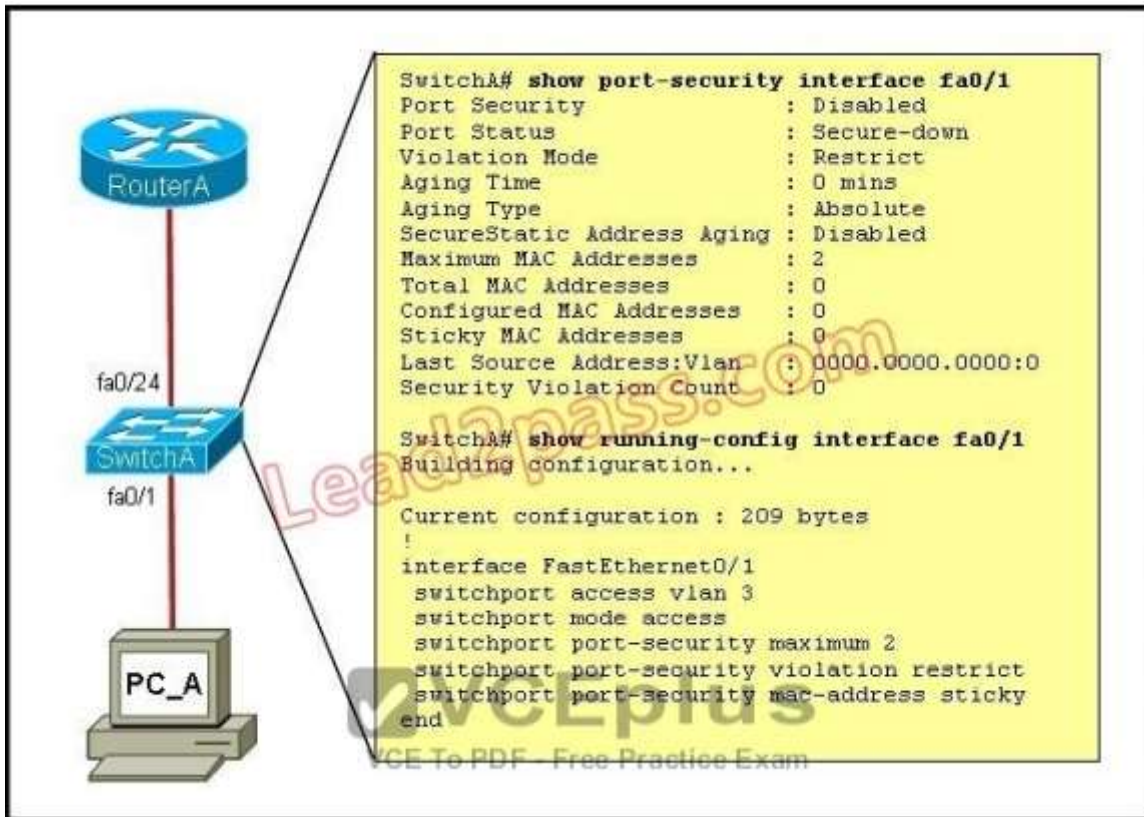

- A. Port security needs to be globally enabled.
- B. Port security needs to be enabled on the interface.
- C. Port security needs to be configured to shut down the interface in the event of a violation.
- D. Port security needs to be configured to allow only one learned MAC address.
- E. Port security interface counters need to be cleared before using the show command.
- F. The port security configuration needs to be saved to NVRAM before it can become active.

Correct Answer: BD

Section: (none)

Explanation

Explanation/Reference:

QUESTION 128

Which three statements about static routing are true? (Choose three.)

- A. It uses consistent route determination.
- B. It is best used for small-scale deployments.
- C. Routing is disrupted when links fail.
- D. It requires more resources than other routing methods.
- E. It is best used for large-scale deployments.
- F. Routers can use update messages to reroute when links fail.

Correct Answer: ABC

Section: (none)

Explanation

Explanation/Reference:

QUESTION 129

```
router eigrp 100
network 172.15.4.0
network 10.4.3.0
network 192.168.4.0
auto summary
```

What are the address that will show at the show ip route if we configure the above statements? (Choose Three.)

- A. 10.0.0.0
- B. 10.4.3.0
- C. 172.15.4.0
- D. 172.15.0.0
- E. 192.168.4.0
- F. 192.168.0.0

Correct Answer: ADE

Section: (none)

Explanation

Explanation/Reference:

QUESTION 130

Which feature facilitate the tagging of a specific VLAN?

- A. Routing
- B. Hairpinning
- C. Encapsulation
- D. Switching

Correct Answer: C

Section: (none)

Explanation

Explanation/Reference:

QUESTION 131

What does split horizon prevent?

- A. routing loops, link state
- B. routing loops, distance vector
- C. switching loops, STP
- D. switching loops, VTP

Correct Answer: B

Section: (none)

Explanation

Explanation/Reference:

QUESTION 132

Which value to use in HSRP protocol election process ?

- A. interface
- B. virtual IP address
- C. priority
- D. router ID

Correct Answer: C

Section: (none)

Explanation

Explanation/Reference:

QUESTION 133

Which of the following is needed to be enable back the role of active in HSRP?

- A. preempt
- B. priority
- C. other options
- D. other options

Correct Answer: A

Section: (none)

Explanation

Explanation/Reference:

QUESTION 134

Which command is used to show the interface status of a router?

- A. show interface status
- B. show ip interface brief
- C. show ip route
- D. show interface

Correct Answer: B

Section: (none)

Explanation

Explanation/Reference:

QUESTION 135

Which of the following privilege level is the most secured?

- A. Level 0

- B. Level 1
- C. Level 15
- D. Level 16

Correct Answer: C

Section: (none)

Explanation

Explanation/Reference:

QUESTION 136

Which IPV6 feature is supported in IPV4 but is not commonly used?

- A. unicast
- B. multicast
- C. anycast
- D. broadcast

Correct Answer: C

Section: (none)

Explanation

Explanation/Reference:

QUESTION 137

Which two statements are true about IPv6 Unique Local Addresses? (Choose Two.)

- A. It is the counterpart of IPv4 private addresses
- B. It uses FC00::/7 as prefix
- C. wrong
- D. wrong

Correct Answer: AB

Section: (none)

Explanation

Explanation/Reference:

QUESTION 138

Which range represents the standard access list?

- A. 99
- B. 150
- C. 299
- D. 2000

Correct Answer: A

Section: (none)

Explanation

Explanation/Reference:

QUESTION 139

What to do when the router password was forgotten?

- A. use default password cisco to reset
- B. access router physically
- C. use ssl/vpn
- D. Type confreg 0x2142 at the rommon 1

Correct Answer: D

Section: (none)

Explanation

Explanation/Reference:

QUESTION 140

What is true about Cisco Discovery Protocol?

- A. it discovers the routers, switches and gateways.
- B. it is network layer protocol
- C. it is physical and data link layer protocol
- D. it is proprietary protocol

Correct Answer: D

Section: (none)

Explanation

Explanation/Reference:

QUESTION 141

Which of the following encrypts the traffic on a leased line?

- A. telnet
- B. ssh
- C. vtp
- D. vpn
- E. dmvpn

Correct Answer: B

Section: (none)

Explanation

Explanation/Reference:

QUESTION 142

How do you configure a hostname?

- A. Router(config)#hostname R1

Correct Answer: A

Section: (none)

Explanation

Explanation/Reference:

QUESTION 143

How do you maintain security in multiple websites?

- A. vpn
- B. dmvpn
- C. other
- D. other

Correct Answer: A

Section: (none)

Explanation

Explanation/Reference:

QUESTION 144

Refer to the exhibit. Switch-1 needs to send data to a host with a MAC address of 00b0.d056.efa4. What will Switch-1 do with this data?

```
Switch-1# show mac address-table
Dynamic Addresses Count:          3
Secure Addresses (User-defined) Count: 0
Static Addresses (User-defined) Count: 0
System Self Addresses Count:     41
Total Mac addresses:              50
Non-static Address Table:
-----
Destination Address  Address Type  VLAN  Destination Port
-----
0010.0de0.e289      Dynamic      1     FastEthernet0/1
0010.7b00.1540      Dynamic      2     FastEthernet0/3
0010.7b00.1545      Dynamic      2     FastEthernet0/2
```

- A. Switch-1 will drop the data because it does not have an entry for that MAC address.
- B. Switch-1 will flood the data out all of its ports except the port from which the data originated.
- C. Switch-1 will send an ARP request out all its ports except the port from which the data originated.
- D. Switch-1 will forward the data to its default gateway.

Correct Answer: B

Section: (none)

Explanation

Explanation/Reference:

QUESTION 145

```
interface fa0/0
ip address x.x.x.33 255.255.255.224
router bgp XXX
```

neighbor x.x.x.x remote as x.x.x.x

You need to advertise the network of Int fa0/0.

- A. x.x.x.32 mask 255.255.255.224
- B. x.x.x.32 255.255.255.224
- C. x.x.x.32 mask 0.0.0.31=
- D. x.x.x.33 mask 255.255.255.224

Correct Answer: A

Section: (none)

Explanation

Explanation/Reference:

QUESTION 146

What routing protocol use first-hand information?

- A. link-state
- B. distance-vector
- C. path-vector
- D. other

Correct Answer: A

Section: (none)

Explanation

Explanation/Reference:

QUESTION 147

What field is consist of 6 bytes in the field identification frame in IEEE 802.1Q?

- A. SA
- B. DA
- C. FCS
- D. other

Correct Answer: A

Section: (none)

Explanation

Explanation/Reference:

QUESTION 148

What is new in HSRPv2?

- A. preempt
- B. a greater number in hsrp group field
- C. other
- D. other

Correct Answer: B

Section: (none)

Explanation

Explanation/Reference:

QUESTION 149

What's are true about MPLS?

- A. It use a label to separete traffic from several costumer
- B. It use IPv4 IPv6
- C. other
- D. other

Correct Answer: A

Section: (none)

Explanation

Explanation/Reference:

QUESTION 150

A network engineer wants to allow a temporary entry for a remote user with a specific username and password so that the user can access the entire network over the internet.
Which ACL can be used?

- A. reflexive
- B. extended
- C. standard
- D. dynamic

Correct Answer: D

Section: (none)

Explanation

Explanation/Reference:

QUESTION 151

Which command is necessary to permit SSH or Telnet access to a cisco switch that is otherwise configured for these vty line protocols?

- A. transport type all
- B. transport output all
- C. transport preferred all
- D. transport input all

Correct Answer: D

Section: (none)

Explanation

Explanation/Reference:

QUESTION 152

What should be part of a comprehensive network security plan?

- A. Allow users to develop their own approach to network security
- B. Physically secure network equipment from potential access by unauthorized individuals
- C. Encourage users to use personal information in their passwords to minimize the likelihood of passwords being forgotten
- D. Delay deployment of software patches and updates until their effect on end-user equipment is well known and widely reported
- E. Minimize network overhead by deactivating automatic antivirus client updates

Correct Answer: B

Section: (none)

Explanation

Explanation/Reference:

QUESTION 153

Which two Cisco IOS commands, used in troubleshooting, can enable debug output to a remote location? (Choose two.)

- A. no logging console
- B. logging host ip-address
- C. terminal monitor
- D. show logging | redirect flash:output.txt
- E. snmp-server enable traps syslog

Correct Answer: BC

Section: (none)

Explanation

Explanation/Reference:

QUESTION 154

Which component of the Cisco SDN solution serves as the centralized management system?

- A. Cisco OpenDaylight
- B. Cisco ACI
- C. Cisco APIC
- D. Cisco IWAN

Correct Answer: C

Section: (none)

Explanation

Explanation/Reference:

QUESTION 155

Which command is used to build DHCP pool?

- A. ip dhcp pool DHCP
- B. ip dhcp conflict
- C. ip dhcp-server pool DHCP
- D. ip dhcp-client pool DHCP

Correct Answer: C

Section: (none)

Explanation

Explanation/Reference:

QUESTION 156

Which command can you enter to verify echo request and echo reply?

- A. ping
- B. traceroute
- C. tracert
- D. telnet

Correct Answer: A

Section: (none)

Explanation

Explanation/Reference:

QUESTION 157

What is the two benefits of DHCP snooping? (Choose two.)

- A. static reservation
- B. DHCP reservation
- C. prevent DHCP rouge server
- D. prevent untrusted host and servers to connect

Correct Answer: BD

Section: (none)

Explanation

Explanation/Reference:

QUESTION 158

What are the three major components of cisco network virtualization? (Choose Three.)

- A. network access control
- B. path isolation
- C. virtual network services
- D. policy enforcement

Correct Answer: ABC

Section: (none)

Explanation

Explanation/Reference:

QUESTION 159

What is called when variance with two times of metric?

- A. unequal cost load balancing
- B. path selection
- C. equal cost load balancing
- D. other

Correct Answer: A

Section: (none)

Explanation

Explanation/Reference:

QUESTION 160

Standard industrialized protocol of etherchannel?

- A. LACP
- B. PAGP
- C. PRP
- D. REP

Correct Answer: A

Section: (none)

Explanation

Explanation/Reference:

QUESTION 161

Two features of the extended ping command? (Choose two.)

- A. It can send a specific number of packet
- B. It can send packet from specified interface of IP address
- C. It can resolve the destination host name
- D. It can ping multiple host at the same time

Correct Answer: AB

Section: (none)

Explanation

Explanation/Reference:

QUESTION 162

What command is used to configure a switch as authoritative NTP server?

- A. ntp master 3
- B. ntp peer IP
- C. ntp server IP
- D. ntp source IP

Correct Answer: A

Section: (none)

Explanation

Explanation/Reference:

QUESTION 163

Two statements about syslog logging?

- A. Syslog logging is disabled by default
- B. Messages are stored in the internal memory of device
- C. Messages can be erased when device reboots
- D. Messages are stored external to the device
- E. other
- F. other

Correct Answer: AD

Section: (none)

Explanation

Explanation/Reference:

QUESTION 164

How to enable vlans automatically across multiple switches?

- A. Configure VLAN
- B. Confiture NTP
- C. Configure each VLAN
- D. Configure VTP

Correct Answer: D

Section: (none)

Explanation

Explanation/Reference:

QUESTION 165

Which password types are encrypted?

- A. SSH
- B. Telnet
- C. enable secret
- D. enable password

Correct Answer: C

Section: (none)

Explanation

Explanation/Reference:

QUESTION 166

What is the benefit of point-to-point leased line? (Choose two.)

- A. Low cost
- B. Full-mesh capability
- C. Flexibility of design

D. Simply configuration

Correct Answer: CD

Section: (none)

Explanation

Explanation/Reference:

QUESTION 167

What is the binary pattern of unique ipv6 unique local address?

A. 00000000

B. 11111100

C. 11111111

D. 11111101

Correct Answer: B

Section: (none)

Explanation

Explanation/Reference:

QUESTION 168

Which statemnet about ACLs is true?

A. An ACL have must at least one permit action, else it just blocks all traffic.

B. ACLs go bottom-up through the entries looking for a match

C. An ACL has a an implicit permit at the end of ACL.

D. ACLs will check the packet against all entries looking for a match.

Correct Answer: A

Section: (none)

Explanation

Explanation/Reference:

QUESTION 169

What is the cause of the Syslog output messages?

A. The EIGRP neighbor on Fa0/1 went down due to a failed link.

B. The EIGRP neighbor connected to Fa0/1 is participating in a different EIGRP process, causing the adjacency to go down.

C. A shut command was executed on interface Fa0/1, causing the EIGRP adjacency to go down.

D. Interface Fa0/1 has become error disabled, causing the EIGRP adjacency to go down.

Correct Answer: C

Section: (none)

Explanation

Explanation/Reference:

QUESTION 170

What are contained in layer 2 ethernet frame? (Choose Three.)

- A. Preamble
- B. TTL
- C. Type/length
- D. Frame check sequence
- E. version
- F. others

Correct Answer: ACD

Section: (none)

Explanation

Explanation/Reference:

QUESTION 171

What utility is used for shadowed rules?

- A. Create an action plan
- B. Implement an action plan
- C. Gather facts
- D. others

Correct Answer: B

Section: (none)

Explanation

Explanation/Reference: